

Temporal Logic Patterns for Querying Qualitative Models of Genetic Regulatory Networks

Pedro T. Monteiro^{1,2} Delphine Ropers¹ Radu Mateescu¹
Ana T. Freitas² Hidde de Jong¹

¹INRIA Grenoble - Rhône-Alpes

²IST/INESC-ID Lisboa

18th European Conference on Artificial Intelligence
Patras, Greece



Outline

- 1 *Introduction*
 - Motivation: qualitative simulation of large genetic regulatory networks
 - Computational approach: formal verification
- 2 *Query patterns for formal verification*
 - Definition of patterns: why patterns?
 - Proposed patterns
 - Translation to temporal logic
- 3 *Analysis of the carbon starvation response in *E.coli**
 - Carbon starvation response model
 - Analysis using query patterns
- 4 *Conclusions and perspectives*

1 Introduction

- Motivation: qualitative simulation of large genetic regulatory networks
- Computational approach: formal verification

2 Query patterns for formal verification

- Definition of patterns: why patterns?
- Proposed patterns
- Translation to temporal logic

3 Analysis of the carbon starvation response in *E.coli*

- Carbon starvation response model
- Analysis using query patterns

4 Conclusions and perspectives

Motivation

Qualitative simulation of dynamical systems

Some real world problems lack quantitative information (Kuipers, 1994)

Biological systems

Study of the interactions between molecular components, and how these interactions give rise to the function and behavior of those systems

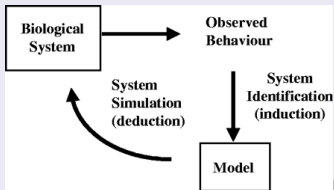

King, Garrett and Coghill, 2005

Use of qualitative models to analyze genetic regulatory networks

- Understanding how particular molecular mechanisms control a cellular process
- Predicting novel phenomena that can be confronted with experimental data

Examples of qualitative models in biology

- Regulation of arginine anabolism (Thomas et al., 1995)
- Intracellular thiamine kinetics in the intestine tissue (Bellazzi et al., 2001)
- Simulation of Glycolysis (King et al., 2005)
- ...

Use of qualitative models to analyze genetic regulatory networks

- Understanding how particular molecular mechanisms control a cellular process
- Predicting novel phenomena that can be confronted with experimental data

Examples of qualitative models in biology

- Regulation of arginine anabolism (Thomas et al., 1995)
- Intracellular thiamine kinetics in the intestine tissue (Bellazzi et al., 2001)
- Simulation of Glycolysis (King et al., 2005)
- ...

Motivation

The network of global regulators in *E. coli*

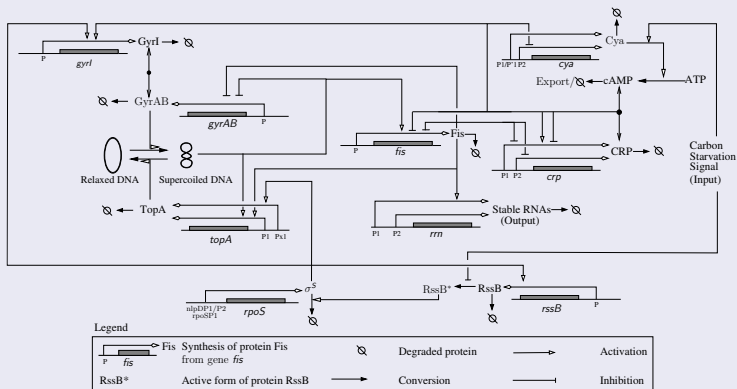

Problem

Explosion of the number of qualitative behaviors when dealing with large and complex networks



Motivation

The network of global regulators in *E. coli*

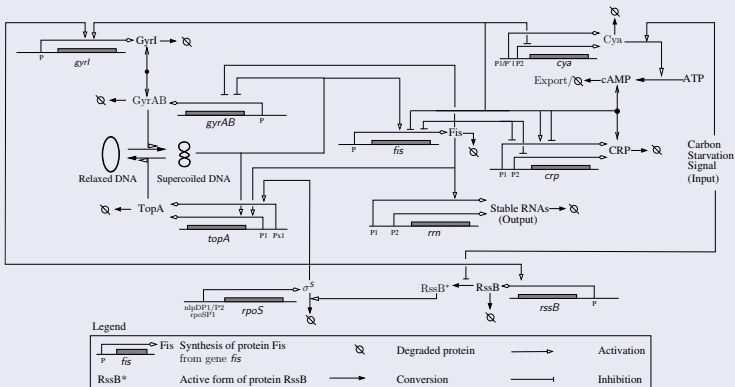

Problem

Explosion of the number of qualitative behaviors when dealing with large and complex networks

Computational approach

Use of formal verification techniques

Formal verification based on temporal logic and model checking provides a powerful technology for the analysis of qualitative models (Shults and Kuipers, 1997)

Existing examples of model checking of qualitative models in biology

- Mucus production in *P. aeruginosa*, Bernot et al. (2004)
- Carbon starvation response in *E.coli*, Batt et al. (2005)
- ERK intracellular signalling pathway, Calder et al. (2005)

Computational approach

Use of formal verification techniques

Formal verification based on temporal logic and model checking provides a powerful technology for the analysis of qualitative models (Shults and Kuipers, 1997)

Existing examples of model checking of qualitative models in biology

- Mucus production in *P. aeruginosa*, Bernot et al. (2004)
- Carbon starvation response in *E.coli*, Batt et al. (2005)
- ERK intracellular signalling pathway, Calder et al. (2005)

Computational approach

Outline of approach

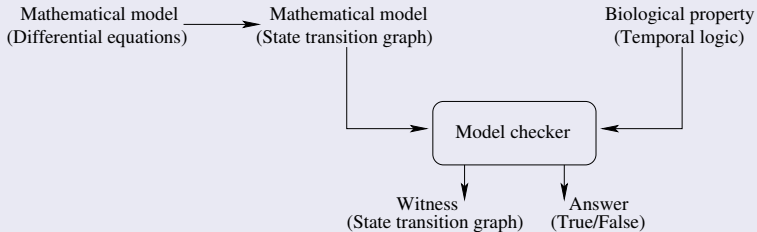

Computational approach

Outline of approach

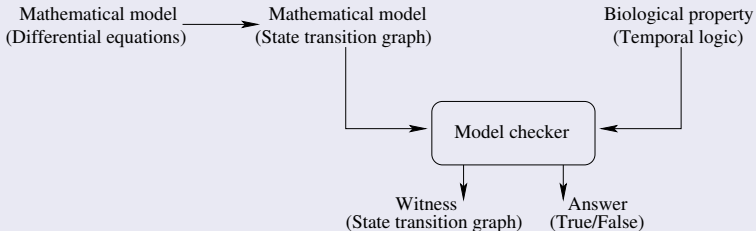

Example of model checking

State transition graph

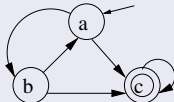

Temporal logic property
 $a \wedge EF(b \wedge EF(c U a))$

Computational approach

Outline of approach

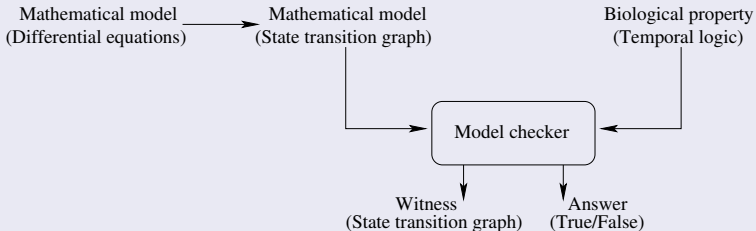

Example of model checking

State transition graph

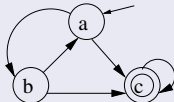

Temporal logic property
 $a \wedge EF(b \wedge EF(c U a))$

Response: **False!**

Computational approach

Problem

- How to pose relevant questions when analyzing a large network model?
- Not easy for non-experts to formulate queries in temporal logic

Example of a temporal logic query

$$EF(\phi_g) \wedge \neg E(\text{TRUE } U \neg([P] > 0.9 \mu M) \wedge E(\text{TRUE } U \phi_g))$$

Proposed solution

Definition of a pattern system capable of:

- Capturing frequently-asked questions by modelers
- Automatic translation to several temporal logics

Computational approach

Problem

- How to pose relevant questions when analyzing a large network model?
- Not easy for non-experts to formulate queries in temporal logic

Example of a temporal logic query

$$EF(\phi_g) \wedge \neg E(\text{TRUE } U \ (\neg([P] > 0.9 \mu M) \wedge E(\text{TRUE } U \ \phi_g)))$$

Proposed solution

Definition of a pattern system capable of:

- Capturing frequently-asked questions by modelers
- Automatic translation to several temporal logics

Computational approach

Problem

- How to pose relevant questions when analyzing a large network model?
- Not easy for non-experts to formulate queries in temporal logic

Example of a temporal logic query

$$EF(\phi_g) \wedge \neg E(\text{TRUE } U (\neg([P] > 0.9 \mu M) \wedge E(\text{TRUE } U \phi_g)))$$

Proposed solution

Definition of a pattern system capable of:

- Capturing frequently-asked questions by modelers
- Automatic translation to several temporal logics

Outline

- 1 *Introduction*
 - Motivation: qualitative simulation of large genetic regulatory networks
 - Computational approach: formal verification
- 2 *Query patterns for formal verification*
 - Definition of patterns: why patterns?
 - Proposed patterns
 - Translation to temporal logic
- 3 *Analysis of the carbon starvation response in *E.coli**
 - Carbon starvation response model
 - Analysis using query patterns
- 4 *Conclusions and perspectives*

Patterns

Pattern definition

Generalized description of commonly occurring questions in a specific application domain

Why patterns?

- Generic enough to cover most frequently-asked questions
- Assist the user in the query formulation process
- Natural language templates that can be translated into temporal logic

Patterns

Pattern definition

Generalized description of commonly occurring questions in a specific application domain

Why patterns?

- Generic enough to cover most frequently-asked questions
- Assist the user in the query formulation process
- Natural language templates that can be translated into temporal logic



Patterns

Formal verification community

- In 1991, Manna and Pnueli introduced classes of properties that are most frequently verified
- In 1999, Dwyer et al. specified a pattern system to capture recurring questions in a specific application domain

Application to qualitative reasoning

But: a systematic definition of temporal logic query patterns has not received any attention in qualitative reasoning thus far



Patterns

Formal verification community

- In 1991, Manna and Pnueli introduced classes of properties that are most frequently verified
- In 1999, Dwyer et al. specified a pattern system to capture recurring questions in a specific application domain

Application to qualitative reasoning

But: a systematic definition of temporal logic query patterns has not received any attention in qualitative reasoning thus far



Pattern identification process

Patterns should have three main characteristics

- Sufficiently generic
- Sufficiently concrete to be comprehensible
- Minimal overlap

Biological questions

Collection of relevant biological questions from the literature

Pattern building

- Grouping of questions into categories: *occurrence/exclusion*, *consequence*, *sequence* and *invariance* of cellular events
- Formulation of patterns for each category that capture essential questions and most relevant variants

Pattern identification process

Patterns should have three main characteristics

- Sufficiently generic
- Sufficiently concrete to be comprehensible
- Minimal overlap

Biological questions

Collection of relevant biological questions from the literature

Pattern building

- Grouping of questions into categories: *occurrence/exclusion, consequence, sequence* and *invariance* of cellular events
- Formulation of patterns for each category that capture essential questions and most relevant variants

Pattern identification process

Patterns should have three main characteristics

- Sufficiently generic
- Sufficiently concrete to be comprehensible
- Minimal overlap

Biological questions

Collection of relevant biological questions from the literature

Pattern building

- Grouping of questions into categories: *occurrence/exclusion, consequence, sequence* and *invariance* of cellular events
- Formulation of patterns for each category that capture essential questions and most relevant variants

Occurrence/Exclusion pattern

Definition: Occurrence/Exclusion pattern

It	is possible	for a state	ϕ	to occur
	is not possible			

Biological examples

- “It is possible for a state with a high concentration of protein P_1 to occur”
- “It is not possible for a state in which protein P_1 and protein P_2 are highly expressed to occur”

Consequence pattern

Definition: Consequence pattern

If a state ϕ occurs,	then it is	possibly	followed by a state ψ
		necessarily	

Biological examples

- “If a state in which a protein P is phosphorylated occurs, then it is possibly followed by a state in which the expression of gene g decreases”
- “If a state in which the concentration of protein P is below $5 \mu M$ occurs, then it is necessarily followed by a state in which the expression of gene g is at the basal level”

Sequence pattern

Definition: Sequence pattern

A state	ψ	is reachable and is	possibly	preceded	at some time	by a state	ϕ
			necessarily		all the time		

Biological examples

- “A state in which reactions R_1 and R_2 occur at a high rate is reachable after 2 min, and is possibly preceded at some time by a state in which the transcription factor P is phosphorylated”
- “A steady state is reachable and is necessarily preceded all the time by a state in which nutrient N is absent”

Invariance pattern

Definition: Invariance pattern

A state	ϕ	can	persist indefinitely
		must	

Biological examples

- “A state in which reaction R occurs at a high rate can persist indefinitely”
- “A state with a basal expression of gene g must persist indefinitely”

Translation to temporal logics

Translation to CTL

Occurrence/Exclusion pattern	CTL
It is possible for a state ϕ to occur	$EF(\phi)$
It is not possible for a state ϕ to occur	$\neg EF(\phi)$
Consequence pattern	
If a state ϕ occurs, then it is possibly followed by a state ψ	$AG(\phi \Rightarrow EF(\psi))$
If a state ϕ occurs, then it is necessarily followed by a state ψ	$AG(\phi \Rightarrow AF(\psi))$
Sequence pattern	
A state ψ is reachable and is possibly preceded at some time by a state ϕ	$EF(\phi \wedge EF(\psi))$
A state ψ is reachable and is possibly preceded all the time by a state ϕ	$E(\phi U \psi)$
A state ψ is reachable and is necessarily preceded at some time by a state ϕ	$EF(\psi) \wedge \neg E(\neg\phi U \psi)$
A state ψ is reachable and is necessarily preceded all the time by a state ϕ	$EF(\psi) \wedge \neg E(T U (\neg\phi \wedge E(T U \psi)))$
Invariance pattern	
A state ϕ can persist indefinitely	$EG(\phi)$
A state ϕ must persist indefinitely	$AG(\phi)$

Translation to other temporal logics

CTRL (Mateescu et al. 2008) and μ -calculus (Kupferman et al. 2000)

Outline

- 1 *Introduction*
 - Motivation: qualitative simulation of large genetic regulatory networks
 - Computational approach: formal verification
- 2 *Query patterns for formal verification*
 - Definition of patterns: why patterns?
 - Proposed patterns
 - Translation to temporal logic
- 3 *Analysis of the carbon starvation response in *E.coli**
 - Carbon starvation response model
 - Analysis using query patterns
- 4 *Conclusions and perspectives*

Carbon starvation response model in *E.coli*

Carbon starvation response in *E. coli*

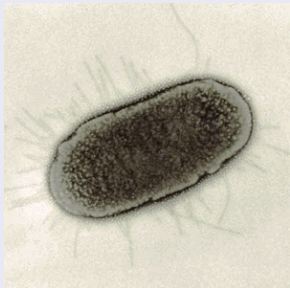

- Transition from exponential phase to stationary phase
- Changes in morphology, gene expression, ...
- Control of growth-phase transition by network of global regulators

Carbon starvation response model in *E.coli*

The network of global regulators

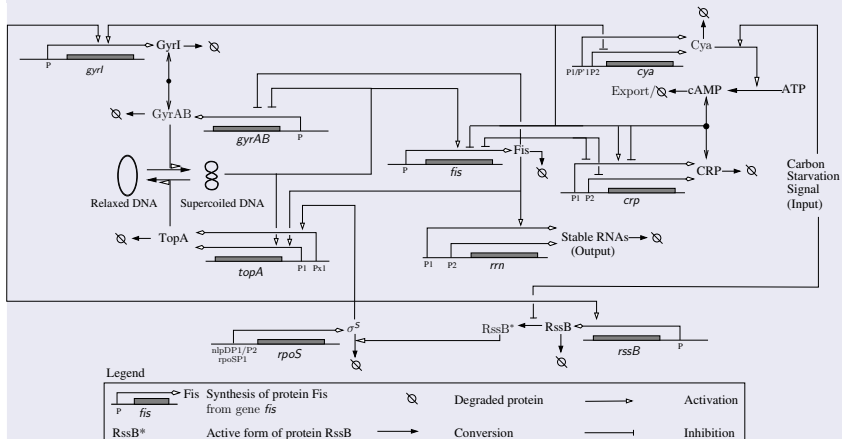

Carbon starvation response model in *E.coli*

The network of global regulators

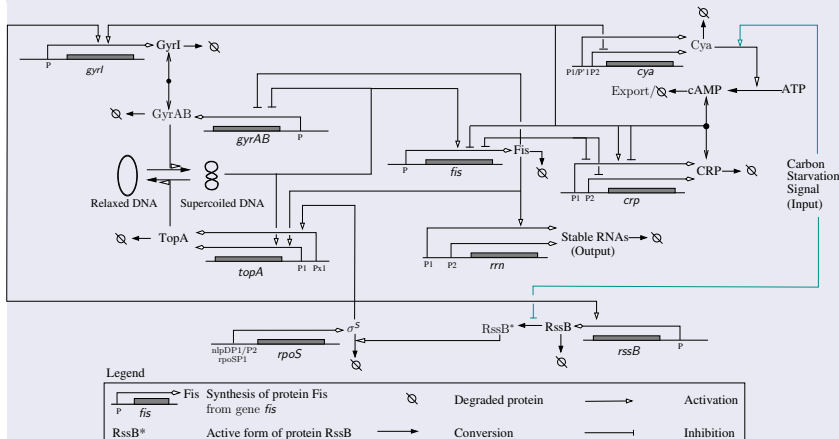

Carbon starvation response model in *E.coli*

The network of global regulators

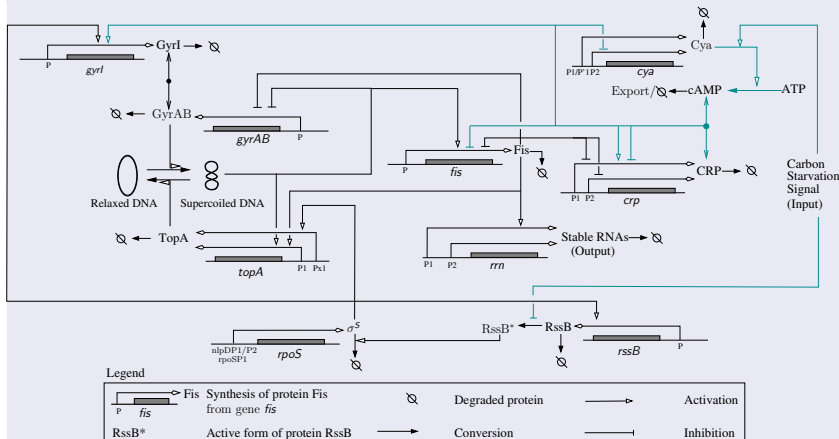

Carbon starvation response model in *E.coli*

The network of global regulators

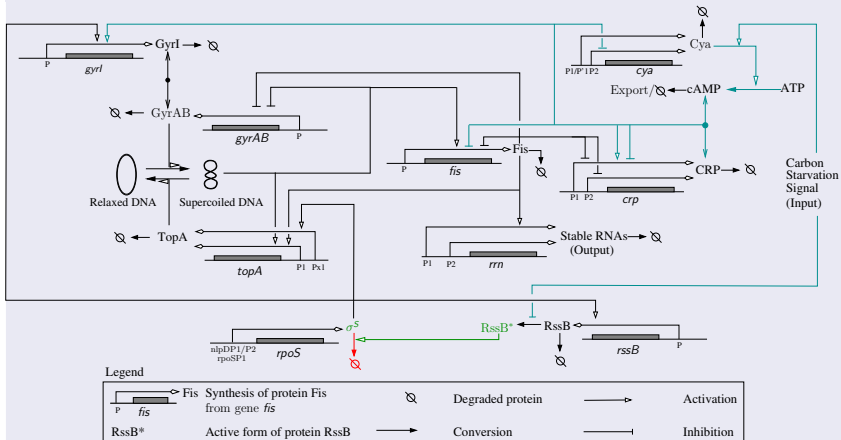

Carbon starvation response model in *E.coli*

The network of global regulators

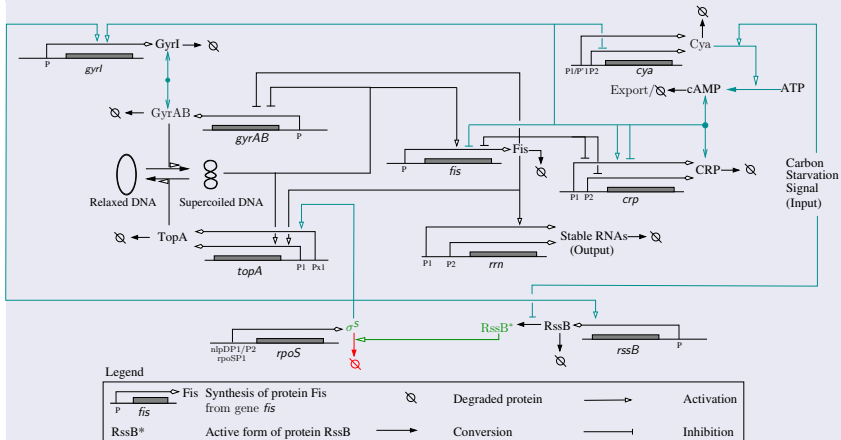

Carbon starvation response model in *E.coli*

The network of global regulators

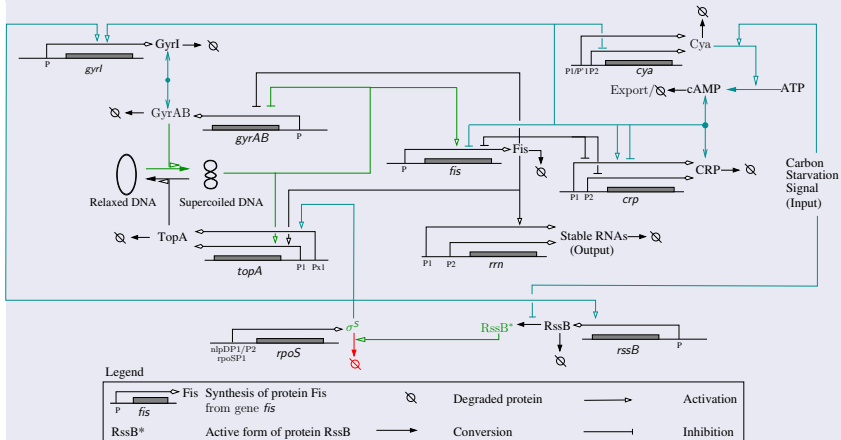

Carbon starvation response model in *E.coli*

The network of global regulators

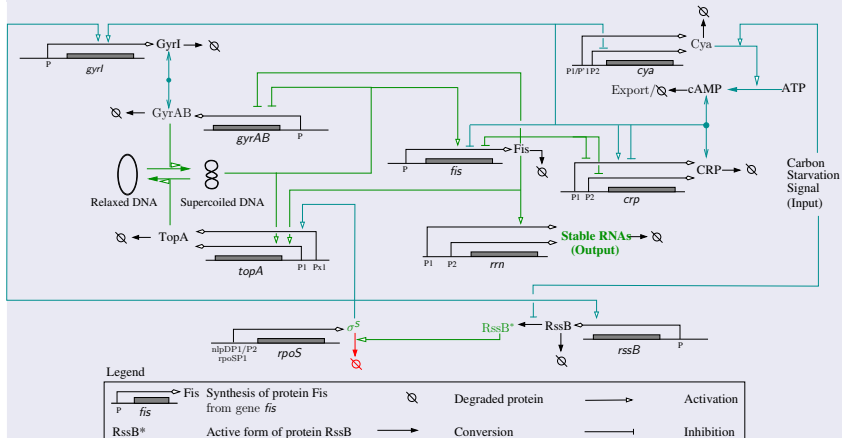

Carbon starvation response model in *E. coli*

The network of global regulators

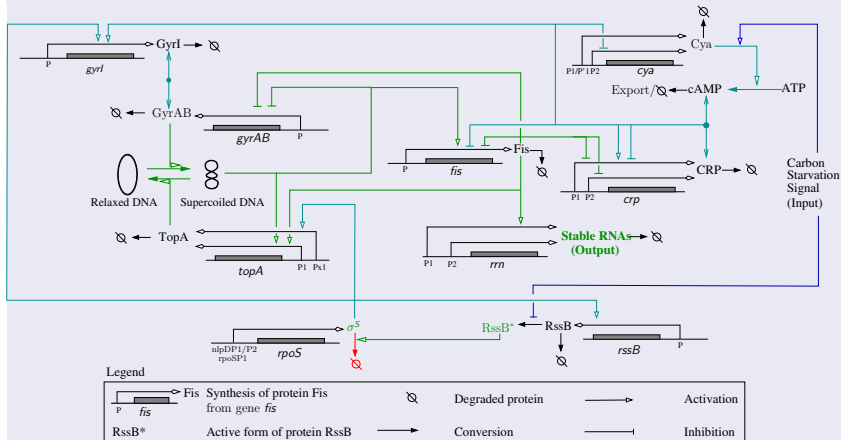

Carbon starvation response model in *E.coli*

The network of global regulators

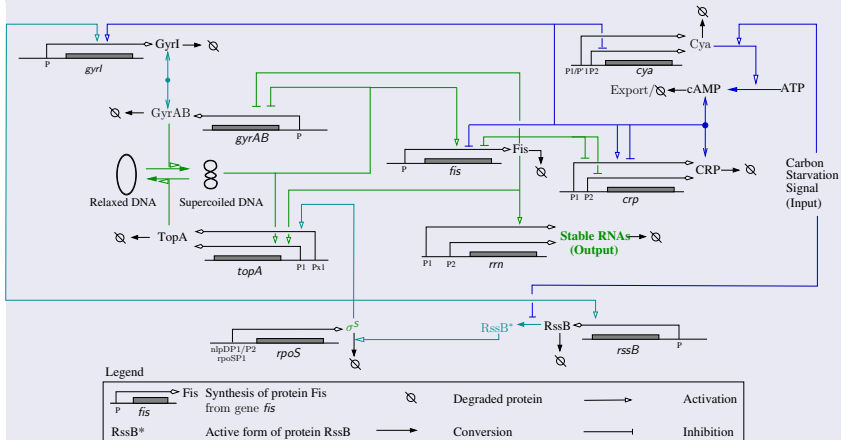

Carbon starvation response model in *E.coli*

The network of global regulators

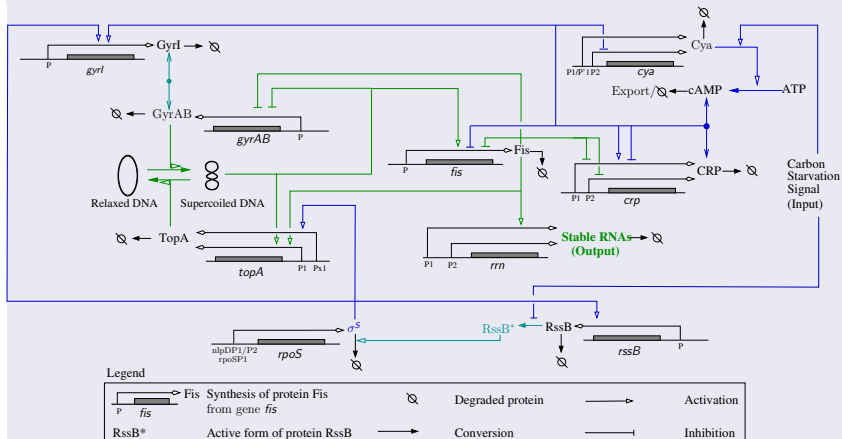

Carbon starvation response model in *E.coli*

The network of global regulators

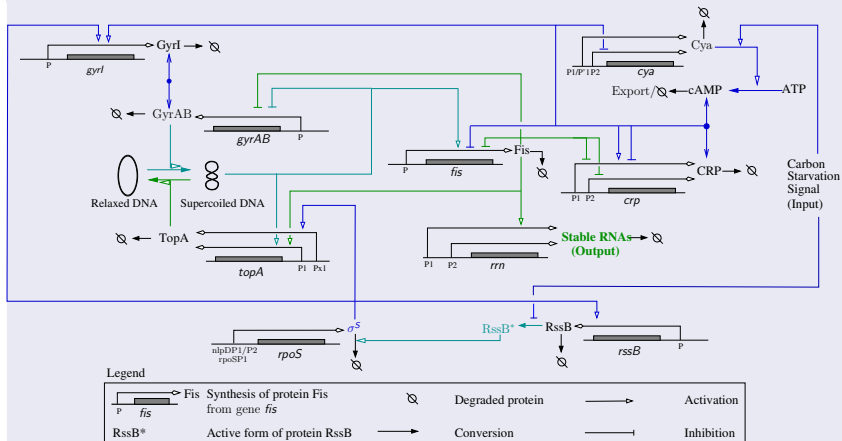

Carbon starvation response model in *E.coli*

The network of global regulators

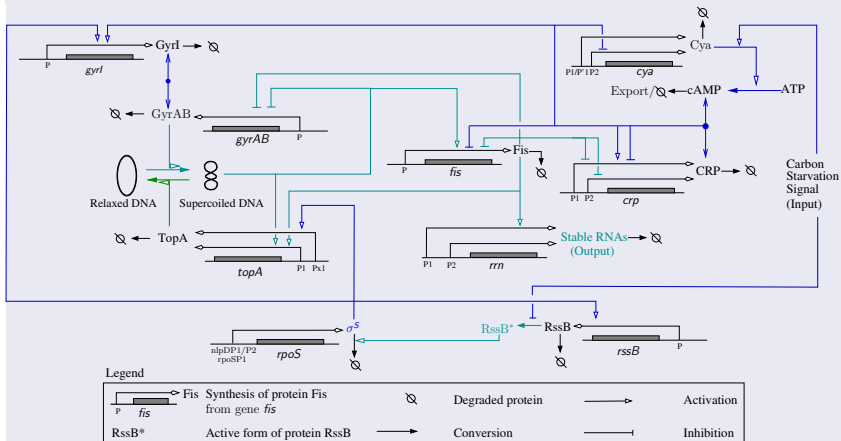

Carbon starvation response model in *E.coli*

Qualitative model

- Model of network of global regulators by means of piecewise-linear (PL) differential equations
- PL model provides coarse-grained picture of the dynamics of genetic regulatory networks

Extension of model of carbon starvation response (Ropers et al. 2006)

- 9 coupled PL differential equations + 1 input variable

$$\dot{x}_{\text{GyrAB}} = \kappa_{\text{GyrAB}} (1 - s^+(x_{\text{GyrAB}}, \theta_{\text{GyrAB}}^2)) s^-(x_{\text{GyrI}}, \theta_{\text{GyrI}}^1) s^-(x_{\text{topA}}, \theta_{\text{topA}}^1) s^-(x_{\text{fis}}, \theta_{\text{fis}}^4) - \gamma_{\text{GyrAB}} x_{\text{GyrAB}}$$

- $\simeq 50$ inequality constraints

$$0 < \theta_{\text{GyrAB}}^1 < \theta_{\text{GyrAB}}^2 < \kappa_{\text{GyrAB}} / \gamma_{\text{GyrAB}} < \max x_{\text{GyrAB}}$$

Qualitative simulation of carbon starvation response

- Qualitative simulation method and computer tool GNA used to analyze models
- Results in large state transition graphs ($\mathcal{O}(10^3)$ – $\mathcal{O}(10^{10})$ states)



Carbon starvation response model in *E.coli*

Qualitative model

- Model of network of global regulators by means of piecewise-linear (PL) differential equations
- PL model provides coarse-grained picture of the dynamics of genetic regulatory networks

Extension of model of carbon starvation response (Ropers et al. 2006)

- 9 coupled PL differential equations + 1 input variable

$$\dot{x}_{\text{gyrAB}} = \kappa_{\text{gyrAB}} (1 - s^+(x_{\text{gyrAB}}, \theta_{\text{gyrAB}}^2) s^-(x_{\text{gyrI}}, \theta_{\text{gyrI}}^1) s^-(x_{\text{topA}}, \theta_{\text{topA}}^1) s^-(x_{\text{fis}}, \theta_{\text{fis}}^4) - \gamma_{\text{gyrAB}} x_{\text{gyrAB}}$$

- $\simeq 50$ inequality constraints

$$0 < \theta_{\text{gyrAB}}^1 < \theta_{\text{gyrAB}}^2 < \kappa_{\text{gyrAB}} / \gamma_{\text{gyrAB}} < \max_{\text{gyrAB}}$$

Qualitative simulation of carbon starvation response

- Qualitative simulation method and computer tool GNA used to analyze models
- Results in large state transition graphs ($\mathcal{O}(10^3)$ – $\mathcal{O}(10^{10})$ states)



Carbon starvation response model in *E.coli*

Qualitative model

- Model of network of global regulators by means of piecewise-linear (PL) differential equations
- PL model provides coarse-grained picture of the dynamics of genetic regulatory networks

Extension of model of carbon starvation response (Ropers et al. 2006)

- 9 coupled PL differential equations + 1 input variable

$$\dot{x}_{\text{gyrAB}} = \kappa_{\text{gyrAB}} (1 - s^+(x_{\text{gyrAB}}, \theta_{\text{gyrAB}}^2) s^-(x_{\text{gyrI}}, \theta_{\text{gyrI}}^1) s^-(x_{\text{topA}}, \theta_{\text{topA}}^1) s^-(x_{\text{fis}}, \theta_{\text{fis}}^4) - \gamma_{\text{gyrAB}} x_{\text{gyrAB}}$$

- $\simeq 50$ inequality constraints

$$0 < \theta_{\text{gyrAB}}^1 < \theta_{\text{gyrAB}}^2 < \kappa_{\text{gyrAB}} / \gamma_{\text{gyrAB}} < \max_{\text{gyrAB}}$$

Qualitative simulation of carbon starvation response

- Qualitative simulation method and computer tool GNA used to analyze models
- Results in large state transition graphs ($\mathcal{O}(10^3)$ – $\mathcal{O}(10^{10})$ states)



Carbon starvation response model in E.coli

Extended outline of approach

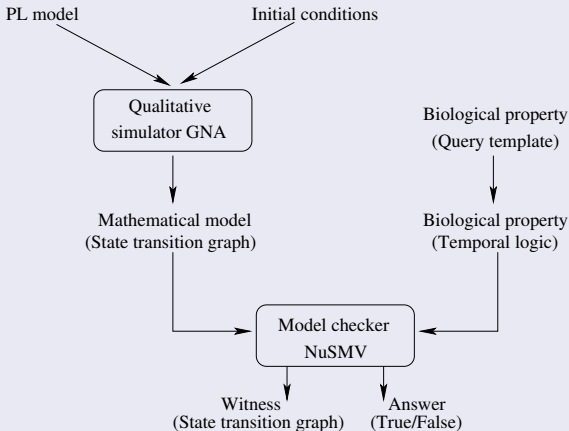

Application to the carbon starvation response model in *E.coli*

Biological question

Is the entry into stationary phase always preceded by the accumulation of the stress response regulator RpoS?

- In the presence of a carbon source, RpoS is degraded through the binding of the protein RssB
- The depletion of the carbon source inactivates RssB, thus allowing RpoS to accumulate
- Entry into stationary phase corresponds to downregulation of *rrn* operons

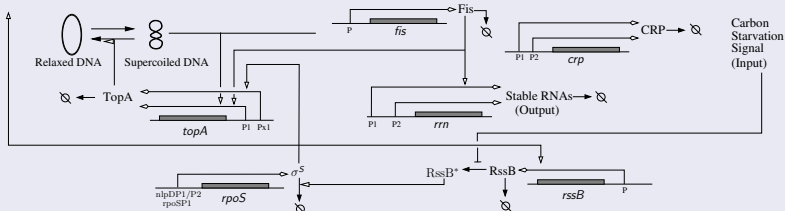

Application to the carbon starvation response model in E.coli

Biological question

Is the entry into stationary phase always preceded by the accumulation of the stress response regulator RpoS?

- In the presence of a carbon source, RpoS is degraded through the binding of the protein RssB
- The depletion of the carbon source inactivates RssB, thus allowing RpoS to accumulate
- Entry into stationary phase corresponds to downregulation of *rrn* operons

Sequence pattern

| A state | $x_{rrn} < \theta_{rrn}$ | is reached and is | necessarily | preceded | at some time | by a state | $x_{rpoS} \geq \theta_{rpoS}^1$ |
CTL: $EF (x_{rrn} < \theta_{rrn}) \wedge \neg E (\neg(x_{rpoS} \geq \theta_{rpoS}^1) U (x_{rrn} < \theta_{rrn}))$

Model-checker response

True



Application to the carbon starvation response model in E.coli

Biological question

Is the entry into stationary phase always preceded by the accumulation of the stress response regulator RpoS?

- In the presence of a carbon source, RpoS is degraded through the binding of the protein RssB
- The depletion of the carbon source inactivates RssB, thus allowing RpoS to accumulate
- Entry into stationary phase corresponds to downregulation of *rrn* operons

Sequence pattern

| A state | $x_{rrn} < \theta_{rrn}$ | is reached and is | necessarily | preceded | at some time | by a state | $x_{rpoS} \geq \theta_{rpoS}^1$ |
CTL: $EF (x_{rrn} < \theta_{rrn}) \wedge \neg E (\neg(x_{rpoS} \geq \theta_{rpoS}^1) U (x_{rrn} < \theta_{rrn}))$

Model-checker response

True

Application to the carbon starvation response model in *E.coli*

Occurrence/Exclusion pattern: “Mutual inhibition of Fis and CRP”

| It | is not possible | for a state | $x_{crp} \geq \frac{k_{crp}^1 + k_{crp}^2 + k_{crp}^3}{\gamma_{crp}} \wedge x_{fis} \geq \theta_{fis}^4$ | to occur | and |

| It | is not possible | for a state | $x_{crp} \leq \frac{k_{crp}^1}{\gamma_{crp}} \wedge x_{fis} \leq \theta_{fis}^1$ | to occur |

CTL: $\neg EF(x_{crp} \geq \frac{k_{crp}^1 + k_{crp}^2 + k_{crp}^3}{\gamma_{crp}} \wedge x_{fis} \geq \theta_{fis}^4) \wedge \neg EF(x_{crp} \leq \frac{k_{crp}^1}{\gamma_{crp}} \wedge x_{fis} \leq \theta_{fis}^1)$

Consequence pattern: “Damped oscillations after nutrient upshift”

| If a state | $x_{signal} < \theta_{signal}$ | occurs, then it is | necessarily | followed by a state | *isOscillatoryState* |

CTL: $AG((x_{signal} < \theta_{signal}) \Rightarrow AF(isOscillatoryState))$

Invariance pattern: “Expression of *topA* during growth-phase transitions”

| A state | $x_{topA} < \theta_{topA}^1$ | can | persist indefinitely |

CTL: $EG(x_{topA} < \theta_{topA}^1)$

Application to the carbon starvation response model in *E.coli*

Occurrence/Exclusion pattern: “Mutual inhibition of Fis and CRP”

| It | is not possible | for a state | $x_{crp} \geq \frac{k_{crp}^1 + k_{crp}^2 + k_{crp}^3}{\gamma_{crp}} \wedge x_{fis} \geq \theta_{fis}^4$ | to occur | and |

| It | is not possible | for a state | $x_{crp} \leq \frac{k_{crp}^1}{\gamma_{crp}} \wedge x_{fis} \leq \theta_{fis}^1$ | to occur |

CTL: $\neg EF(x_{crp} \geq \frac{k_{crp}^1 + k_{crp}^2 + k_{crp}^3}{\gamma_{crp}} \wedge x_{fis} \geq \theta_{fis}^4) \wedge \neg EF(x_{crp} \leq \frac{k_{crp}^1}{\gamma_{crp}} \wedge x_{fis} \leq \theta_{fis}^1)$

Consequence pattern: “Damped oscillations after nutrient upshift”

| If a state | $x_{signal} < \theta_{signal}$ | occurs, then it is | necessarily | followed by a state | *isOscillatoryState* |

CTL: $AG((x_{signal} < \theta_{signal}) \Rightarrow AF(isOscillatoryState))$

Invariance pattern: “Expression of *topA* during growth-phase transitions”

| A state | $x_{topA} < \theta_{topA}^1$ | can | persist indefinitely |

CTL: $EG(x_{topA} < \theta_{topA}^1)$

Application to the carbon starvation response model in *E.coli*

Occurrence/Exclusion pattern: “Mutual inhibition of Fis and CRP”

| It | is not possible | for a state | $x_{crp} \geq \frac{k_{crp}^1 + k_{crp}^2 + k_{crp}^3}{\gamma_{crp}} \wedge x_{fis} \geq \theta_{fis}^4$ | to occur | and |

| It | is not possible | for a state | $x_{crp} \leq \frac{k_{crp}^1}{\gamma_{crp}} \wedge x_{fis} \leq \theta_{fis}^1$ | to occur |

CTL: $\neg EF(x_{crp} \geq \frac{k_{crp}^1 + k_{crp}^2 + k_{crp}^3}{\gamma_{crp}} \wedge x_{fis} \geq \theta_{fis}^4) \wedge \neg EF(x_{crp} \leq \frac{k_{crp}^1}{\gamma_{crp}} \wedge x_{fis} \leq \theta_{fis}^1)$

Consequence pattern: “Damped oscillations after nutrient upshift”

| If a state | $x_{signal} < \theta_{signal}$ | occurs, then it is | necessarily | followed by a state | *isOscillatoryState* |

CTL: $AG((x_{signal} < \theta_{signal}) \Rightarrow AF(isOscillatoryState))$

Invariance pattern: “Expression of *topA* during growth-phase transitions”

| A state | $x_{topA} < \theta_{topA}^1$ | can | persist indefinitely |

CTL: $EG(x_{topA} < \theta_{topA}^1)$



- 1 *Introduction*
 - Motivation: qualitative simulation of large genetic regulatory networks
 - Computational approach: formal verification
- 2 *Query patterns for formal verification*
 - Definition of patterns: why patterns?
 - Proposed patterns
 - Translation to temporal logic
- 3 *Analysis of the carbon starvation response in *E.coli**
 - Carbon starvation response model
 - Analysis using query patterns
- 4 *Conclusions and perspectives*

Conclusions

Increasingly large qualitative models

Formal verification techniques are promising tools for upscaling the analysis of qualitative models of genetic regulatory networks

Difficulty to formulate appropriate questions in temporal logics

Formulation of patterns in the form of query templates

- Capture most frequently-asked questions by modelers
- Automatic translation to several temporal logics

Compromise between patterns and temporal logic

- Patterns help users formulate frequent queries
- But: they do not express all user queries

Conclusions

Increasingly large qualitative models

Formal verification techniques are promising tools for upscaling the analysis of qualitative models of genetic regulatory networks

Difficulty to formulate appropriate questions in temporal logics

Formulation of patterns in the form of query templates

- Capture most frequently-asked questions by modelers
- Automatic translation to several temporal logics

Compromise between patterns and temporal logic

- Patterns help users formulate frequent queries
- But: they do not express all user queries

Conclusions

Increasingly large qualitative models

Formal verification techniques are promising tools for upscaling the analysis of qualitative models of genetic regulatory networks

Difficulty to formulate appropriate questions in temporal logics

Formulation of patterns in the form of query templates

- Capture most frequently-asked questions by modelers
- Automatic translation to several temporal logics

Compromise between patterns and temporal logic

- Patterns help users formulate frequent queries
- But: they do not express all user queries

Environment for qualitative modeling and formal verification

Integration of the query patterns into the modeling tool GNA

The screenshot displays the GNA modeling tool interface. On the left, a tree view shows the model structure for 'Model (transreg56-6_0)', including variables like Crp, Cys, Fic, CysA8, CytI, Pps5, Rps8, Signal, TopA, and rrm. The main window is titled 'Variable Crp' and shows the state equation:
$$\frac{d}{dt} Crp = k_{Crp_1} + k_{Crp_2} * s - (P15, t_{F15_2}) * s + (Crp, t_{Crp_1}) * s + (Cys, t_{Cys_1}) * s + (Sig) + k_{Crp_3} * s - (P15, t_{F15_1}) - g_{Crp} * Crp$$
 Below the equation is an 'Influence graph' showing nodes for Signal, Crp, Rps8, Pps5, TopA, and rrm, connected by green lines representing regulatory interactions.

Query patterns in qualitative simulation

Generalization of query patterns to other qualitative reasoning applications



Environment for qualitative modeling and formal verification

Integration of the query patterns into the modeling tool GNA

The screenshot displays the GNA modeling tool interface. On the left, a tree view shows the model structure for 'Model (transreg56-6_0)', including variables like Crp, Cys, Fic, and various parameters. The main window shows the 'Variable Crp' definition. It includes a 'Variable type' section with 'State variable' selected, and a 'State equation' section with the following differential equation:

$$\frac{d}{dt} Crp = k_{Crp_1} + k_{Crp_2} * s - (P15_t_F1s_Z2) * s + (Crp_t_Crp_1) * s + (Cys_t_Cys_1) * s + (G1g) + k_{Crp_3} * s - (P15_t_F1s_L1) - g_Crp * Crp$$

Below the equation is an 'Influence graph' showing nodes for 'Signal', 'Took', 'RpoS', 'RpoH', and 'rm'. Green arrows indicate the influence of these nodes on the 'Crp' variable.

Query patterns in qualitative simulation

Generalization of query patterns to other qualitative reasoning applications

Thank you

Questions?

